

20090107000641
Electronic Recording 01/07/2009
Rick Campbell 12:19PM
Stark County Recorder T20090000405
Pages:37 F:Fees:\$312.00 MISC

Cross-reference to Instrument
Number 200603230017045

AMENDED AND RESTATED DECLARATION OF COMMUNITY COVENANTS*

FOR

THE SANCTUARY
(Phase No. 1 and Phase No. 2)

Lots 1 through 54, both inclusive, and Lots 86-118, both inclusive, as shown on the Plats for the same recorded in Instrument Nos. 200511290079996 & 200511290079997 of the Stark County Records

CITY OF NORTH CANTON, STARK COUNTY, OHIO

DEVELOPED BY:

McKinley-Applegrove, Ltd.
an Ohio limited liability company
1201 South Main Street
North Canton, Ohio 44720



* The Declaration of Community Covenants for The Sanctuary Phase No. 1 and Phase No. 2 is being amended and restated as provided for herein. This Amended and Restated Declaration is intended to wholly replace the original Declaration, which was recorded on March 23, 2006 in Instrument Number 200603230017045 of the Stark County Records.

THIS AMENDED AND RESTATED DECLARATION OF COMMUNITY COVENANTS for The Sanctuary Phase No. 1 and Phase No. 2 is made this ____ day of October, 2008, by McKINLEY-APPLEGROVE, LTD., an Ohio limited liability company, (hereinafter "Developer").

RECITALS:

WHEREAS, Developer was the owner and developer of Lots 1 through 54, both inclusive, and Lots 86-118, both inclusive, in The Sanctuary Phases 1 and 2, an allotment located in the City of North Canton, Stark County, Ohio, as the same are set forth in Plat Record Imaging Nos. 200511290079996 and 200511290079997, respectively, of the Stark County Plat Records, hereinafter referred to as the "Development;" and

WHEREAS, Developer caused a Declaration of Community Covenants to be made on March 1, 2006, (the "Declaration"), binding all of the Lots in the Development to certain covenants, conditions, restrictions, easements, and all other matters set forth therein. The Declaration was recorded in Instrument Number 200603230017045 of the Stark County Records; and

WHEREAS, Developer now desires to terminate the Declaration in favor of the within Amended and Restated Declaration which provides, among other things, for the creation and/or designation of Common Areas, Limited Common Areas and Exclusive Easement Areas within the Development as shown on Exhibits A, B, C and D attached hereto; and

WHEREAS, Developer is permitted to amend the Declaration in accordance with Section 7.1.1 of the Declaration, with the consent of the owners of at least two-thirds (2/3) of the lots in the Development; and

WHEREAS, Developer is the owner of at least two-thirds (2/3) of the lots in the Development and agrees to consent to the amendments contained herein.

NOW, THEREFORE, in consideration of the terms and conditions set forth herein, the receipt and sufficiency of which are hereby acknowledged, Developer hereby amends and restates the Declaration as provided for hereafter and declares that the original Declaration shall be terminated upon the recordation hereof.

TABLE OF CONTENTS

Table of Contents	ii
List of Highlighted Restrictions	vi
Preamble	viii
Article I. Restrictions	1
Section 1.1 – Use	1
Section 1.2 – Types of Living Units	1
Section 1.3 – Living Area	1
Section 1.4 – Garages	1
Section 1.5 – Lot Restrictions	2
Section 1.5.1 – Zoning	2
Section 1.5.2 – Riparian Rights	2
Section 1.5.3 – Driveways	2
Section 1.5.4 – Curb Cuts	2
Section 1.5.5 – Corner lots	2
Section 1.5.6 – Variances	2
Section 1.5.7 – Sediment Control	2
Section 1.6 – Prohibited Activities	2
Section 1.6.1 – Non-Residential Uses	3
Section 1.6.2 – Animals	3
Section 1.6.3 – Outbuildings	3
Section 1.6.4 – Swimming Pools	3
Section 1.6.5 – Basketball Hoops	3
Section 1.6.6 – Trash	3
Section 1.6.7 – Temporary Structures	3
Section 1.6.8 – Signs	3
Section 1.6.9 – Nuisances	4
Section 1.6.10 – Storage	4
Section 1.6.11 – Laundry	4
Section 1.6.12 – Fences	4
Section 1.6.13 – Site Lighting	4
Section 1.6.14 – Appearance	4
Section 1.6.15 – Satellite Dishes	4
Section 1.6.16 – Subdivision of Lots	4
Section 1.6.17 – Concrete Block	5
Section 1.7 – Submittals and Approvals	5
Section 1.7.1 – Entity from whom Approval shall be sought	5
Section 1.7.2 – Form of Submittals	5
Section 1.7.3 – Architectural Review Board	5
Section 1.7.3.1 – Establishment	5
Section 1.7.3.2 – Board Responsibilities: Effect of Actions ...	6
Section 1.7.3.3 – Requirements of Plan Approval	6
Section 1.7.3.4 – Basis of Approval	7
Section 1.7.3.5 – Liability Relating to Approvals	7
Section 1.7.3.6 – Requirement for Approval	7
Section 1.8 – Construction	7
Section 1.8.1 – Start of Construction	7
Section 1.8.2 – Requirements of Completion	8
Section 1.8.3 – Upkeep prior to Commencement of Construction	8

	Section 1.9 – Design Standards and Building Restrictions	8
	Section 1.9.1 – Sloped Lots	8
	Section 1.9.2 – Retaining Walls	8
	Section 1.9.3 – Wooded Lots	8
	Section 1.9.4 – Decks and Patios	8
	Section 1.9.5 – Garage Location	8
	Section 1.9.6 – Lights	8
	Section 1.9.7 – Roof Vents	8
	Section 1.9.8 – Foundation	8
	Section 1.9.10 – Mailboxes	8
	Section 1.9.11 – Roofs	9
	Section 1.9.12 – Cable	9
	Section 1.9.13 – Colors	9
	Section 1.9.14 – Landscaping	9
	Section 1.9.15 – Repetition	9
	Section 1.9.16 – Repainting	9
	Section 1.9.17 – Emergency Phone	9
	Section 1.9.18 – Materials, Details and Directions	9
	Section 1.9.18.1 – Building Materials	9
	Section 1.9.19 – Facades	10
	Section 1.9.20 – Windows	10
	Section 1.9.21 – Chimneys	10
	Section 1.9.22 – Sidewalks	10
	Section 1.9.23 – 100-year Floodplain Requirements	10
	Section 1.10 – Streetlights	11
	Section 1.10.1 – Installation/Operation/Cost	11
Article II.	Reservations and Easements	11
	Section 2.1 – Developer’s Right to add Additional Land	11
	Section 2.2 – Future Easement Rights	11
	Section 2.3 – Utility Easements	11
	Section 2.3.1 – Platted Easements	11
	Section 2.3.2 – Relocation of Utility Easements	11
	Section 2.4 – Maintenance and Development Easements	12
	Section 2.5 – Drainage Easements	12
	Section 2.5.1 – Platted Easements	12
	Section 2.5.2 – Lot Perimeter Easements	12
	Section 2.5.3 – Mound Piping Easements	12
	Section 2.6 – Easements for Common Areas	13
	Section 2.7 – Landscape Easements	13
Article III.	Common Areas	13
	Section 3.1 – Establishment of Commons Areas	13
	Section 3.2 – Use of Common Areas	14
	Section 3.3 – Authority to Convey Common Areas	14
	Section 3.4 – Alterations to Common Areas	14
	Section 3.5 – Authority to Borrow Funds	15
	Section 3.6 – Stark Parks Walking Trails	15

Article IV.	The Association	15
	Section 4.1 – Existence, Membership and Voting Rights	15
	Section 4.1.1 – Class “A” Membership and Voting Rights	15
	Section 4.1.2 – Class “B” Membership and Voting Rights	16
	Section 4.2 – Boards and Officers of the Association	16
	Section 4.3 – Rights of the Association	16
	Section 4.4 – Responsibilities of the Association	17
	Section 4.4.1 – Maintenance of Common Areas	17
	Section 4.4.2 – Management	17
	Section 4.4.3 – Rules and Regulations	18
	Section 4.4.4 – Developer’s Rights	18
Article V.	Association Assessments & Fees	18
	Section 5.1 – Definition of Assessments	18
	Section 5.2 – Applicability	19
	Section 5.3 – Creation of Lien and Personal Obligation of Assessments	19
	Section 5.4 – Purpose of Assessments	19
	Section 5.5 – Special Assessments	20
	Section 5.6 – Uniform Rate of Assessments	20
	Section 5.7 – Payment of Assessments	20
	Section 5.8 – Effect of Nonpayment of Assessments; Remedies of the Association	20
	Section 5.9 – No Exemption for Non-Use of Facilities; No Refund of Reserves	20
	Section 5.10 – Initial Contribution	20
Article VI.	Liens	21
	Section 6.1 – Perfection of Lien	21
	Section 6.2 – No Waiver Implied	21
	Section 6.3 – Personal Obligations	21
Article VII.	General Provisions	21
	Section 7.1 – Limits, Modifications and Enforceability	21
	Section 7.1.1 – Modification	21
	Section 7.1.2 – Hardship	22
	Section 7.1.3 – Enforceability	22
	Section 7.2 – Interpretation and Severability	22
	Section 7.3 – Period of Duration	22
	Section 7.4 – Constructive Notice and Acceptance	22
	Section 7.5 – Rights of Mortgagee	23
	Section 7.6 – Mutuality/Enforcement	23
	Section 7.7 – Developer acting as Association or Board	23
	Section 7.8 – Applicability of Declaration.....	23

Exhibits A, B, C & D are also attached hereto.

HIGHLIGHTED PROVISIONS

Section 1.7.3.3(a): Existing and proposed land contours and grades – Developer reserves the right to establish grades and slopes on the lots, Common Areas, Limited Common Areas and Exclusive Easement Areas in the Development and to fix the grade at which any Living Unit shall be constructed or placed, so that grade conforms to the general plan for grade and slope of lots in the Development. The owners of all lots, blocks, open spaces, “Common Areas,” “Limited Common Areas” and “Exclusive Easement Areas,” (all as defined hereinafter), as the same are set forth on the Plats and herein, shall conform to the Sanctuary No. 1 and No. 2 Grading Plan, Sheet SD-4, on file with the Developer and the North Canton Engineers Office. Further, lot owners are restricted from grading in the “Drainage Easements” (hereinafter defined).

Section 1.8.1: Start of Construction - Construction of a Living Unit shall commence within twenty-four (24) months after an individual lot owner takes title to his/her lot. In the event construction has not commenced within the first twenty-four (24) months, the Developer reserves the right to re-purchase the lot from its owner at the same price and on the same terms from which the original owner acquired it from the Developer.

Section 1.9.23: 100-year Floodplain Requirements - The following lots are restricted to an allowable lowest floor elevation due to the 100-year floodplain: 98, 99, 100, 101, 102, 103, 104, 105, 106, 107, 113, 114, 115 & 119, as the same is set forth on the Plats for the Development. The Developer shall provide a benchmark elevation at the location of these lots upon request.

Section 2.3.1: Platted (Utility) Easements - As provided for in the Plats, each lot in the Development shall be subject to a five foot (5') wide easement on the side of each lot as it abuts adjacent lots and a twelve (12.00) foot wide easement at the front of each lot, being parallel with and contiguous to the streets and/or highways within or adjacent to this Development, excluding Applegate St., N.W., for AEP, SBC Ohio, Utility Pipelines, Ltd., Time Warner Cable, and Aqua Ohio, to be used for installing, operating, maintaining and servicing of pole lines, underground cables and conduits. The character of the installation and structures which may be constructed, reconstructed, removed and maintained in, on, and through these easements shall include all incidental appurtenances such as guys, conduits, poles, anchors, transformers, pad mounted transformers, pads, handholes, etc. Said easement rights shall include the right, without liability therefore, to remove trees and landscaping including lawns, flowers or shrubbery within said easement premises which may interfere with the installation, maintenance, repair or operation of electric current, and the right of access, ingress to and from any of the within premises, for exercising any of the purposes of this right of way and easement.

Section 2.5.1: Platted (Drainage) Easements - Each lot in the Development shall be subject to the Sanitary Sewer Easements, Storm Sewer Easements, Public Drainage Easements and Public Drainage Path Easements delineated on the Plats. By the City of North Canton accepting the aforementioned easements, lot owners shall not place or cause to have placed within the easement areas, any fences, landscaping trees, driveways, walks, structures or alter the ground elevation in any way. Should any of the above-mentioned occur, the City shall have the right to remove these items without compensation to the lot owner(s). The City shall only be responsible to re-seed disturbed easement areas as described in the most recent edition of the State of Ohio, Department of Transportation, Construction and Materials Specifications, Item 659 “Seeding and Mulching.”

Section 2.5.2: Lot Perimeter Easements - Each lot in the Development shall have a seven and one-half foot (7.5') easement located around its perimeter for purposes of promoting drainage within the Development. The Developer and/or a subsequently formed Association shall enforce proper maintenance, repair, operation, and control of such drainage easements by the lot owners, at the lot owner's sole cost and expense.

Section 2.5.3: Mound Piping Easements - Easements are hereby created over the Development for the purposes of installing, maintaining, repairing and replacing mound piping, as the same is set forth on the Plats, which mound piping easements are intended to promote drainage within the Development. It shall be the obligation of the Developer and/or a subsequently formed Association to properly maintain, repair, operate and control such easements unless they are accepted by the City of North Canton or another governmental entity having jurisdiction thereof.

PREAMBLE

- A. Developer is the fee simple owner of Lots 1 through 54, both inclusive, and Lots 86-118, both inclusive, in The Sanctuary Phases 1 and 2, an allotment located in the City of North Canton, Stark County, Ohio, as the same are set forth in Plat Record Imaging Numbers 200511290079996 and 200511290079997, respectively, of the Stark County Official Plat Records, hereinafter referred to as the "Development."
- B. Developer desires to develop the Development as a residential community with areas for single-family residences and common areas, facilities and elements (including Common Areas, Limited Common Areas and Exclusive Easement Areas) and to this end, desires to subject the Development to the reservations, covenants, restrictions, conditions, charges and liens hereinafter set forth, each and all of which is and are for the benefit of said Development and each subsequent lot owner thereof or a portion thereof.
- C. Developer, as part of its general plan for the Development, deems it necessary and desirable for the efficient preservation of the value, aesthetic harmony, and amenities of said Development and for the maintenance and preservation of the common areas, facilities and elements, to impose and provide reservations, covenants, restrictions and conditions, hereinafter called the "Restrictions" upon Lots 1 through 54, both inclusive, and Lots 86-118, both inclusive, in said Development, and to create an agency to which should be delegated and assigned the powers of maintaining and administering the common areas, facilities and elements, administering and enforcing the Restrictions, and collecting and disbursing the assessments and charges hereinafter created.
- D. There has been incorporated under the laws of the State of Ohio, as a non-profit corporation, THE SANCTUARY OWNERS ASSOCIATION, INC., hereinafter referred to as the "Association," a corporation not-for-profit, for the purpose of owning, operating, maintaining and administering certain portions of the Development, including the common areas, facilities and elements, and such improvements as may be constructed and developed thereon, with the costs incurred by the Association in connection with said ownership, operating, construction and development, and any maintenance, repair, replacement and administration of such portions of the Development to be an encumbrance upon the Development, as further described herein.
- E. Developer hereby imposes the following Restrictions upon Lots 1 through 54, both inclusive, and Lots 86-118, both inclusive, in the Development and further specifies that these Restrictions shall constitute covenants running with the land and shall be binding upon and inure to the benefit of the Developer, the Association and the respective Grantees in deeds for such real estate, their respective successors, purchasers, heirs, executors, administrators and assigns.

ARTICLE I
RESTRICTIONS

Section 1.1 – Use.

Lots located in the Development shall be used exclusively for single-family residence purposes, and only one such residence with an attached garage (hereinafter the “Living Unit”) shall be permitted on each lot. Developer shall have the right to divide lots for the purpose of adding parts thereof to other lots to be used for one single family Living Unit on the re-configured tracts. No Living Unit shall be used as a hotel, rooming house, boarding house, group home, halfway house or other type of group or communal living by persons not related by blood or marriage. A blood relative may be defined to include only the following: parents and children or stepchildren; brother and sister; half-brother and half-sister, adopted children and children of a spouse, grandparents and grandchildren, aunts, uncles, nephews and nieces; and first cousins. Notwithstanding the foregoing, this restriction on use shall not apply to persons with disabilities and it shall not be used as a means by which to discriminate on the basis of a protected class, including, but not limited to, race, color, religion, national origin and/or handicap.

Section 1.2 – Types of Living Units.

Living Units may be a one-story, two-story, split level, or Cape Cod design: (a) a one-story Living Unit is a structure, the living area being the first floor, constructed with or without a basement, and a space between the first floor ceiling and the roof of adequate height to permit its use as a dwelling place; (b) a two-story Living Unit is a structure, the living area of which is on two levels connected by a stairway, constructed with or without a basement; (c) a split-level Living Unit is a structure, the living area of which is one, two or more levels connected by stairways, constructed with or without a basement; (d) a Cape Cod Living Unit is a structure, the living area of which is on two levels connected by a stairway and constructed with or without a basement. The upper level is constructed within the gable portion of the roof, with window penetrations made by the use of dormers.

Section 1.3 – Living Area.

The living area of any Living Unit shall be not less than the square footage hereinafter set forth in Section 1.3.1. “Living Area” shall not include garages, attics, basements, breezeways, patios, or any enclosed areas not heated for year-round living. The area of any Living Unit shall be computed on the outside foundation of the first floor and the exterior dimensions of the second floor. In the case of a Cape Cod design, the second floor area shall be computed from the outside dimensions of the knee walls. In the case of open ceilings to the second floor, the upper open space may be computed as second floor footage.

Section 1.4 – Garages.

No garages shall be constructed on a lot which are separated from the main Living Unit. All garages must be at least four hundred (400) square feet.

Section 1.5 – Lot Restrictions.

Section 1.5.1 – Zoning. No Living Unit shall be constructed on any lot, any part of which is in violation of any front, side, or rear setback lines and any other requirements established by the North Canton City Zoning Ordinance, establishing such setback requirements within an R-50 or R-70 zoning classification, as such requirements are in effect at the time of construction of a Living Unit.

Section 1.5.2 – Riparian Rights. No Living Unit shall be constructed on any lot, any part of which is in violation of any stream and/or wetland setback lines and any other requirements established by the North Canton City Zoning Ordinance, establishing such setback requirements within an R-50 or R-70 zoning classification, or as delineated on the Plats of the Development, as such requirements and plat restrictions are in effect at the time of construction of a Living Unit.

Section 1.5.3 – Driveways. Concrete driveways are required. Other material may be considered, but must be approved by the Architectural Review Board. All driveways shall be paved within six (6) months after completion of the residence. Driveways shall be not wider than twenty-two feet (22') from the front setback line to the street unless approved in writing by Developer or the Architectural Review Board.

Section 1.5.4 – Curb Cuts. Drain lines connected directly to the storm sewer are provided behind the concrete curb. Downspout drains are to be connected to this drain line. Curb cuts for drain lines are not permitted.

Section 1.5.5 – Corner lots. The Developer or the Architectural Review Board shall have sole discretion as to which street a Living Unit will front on.

Section 1.5.6 – Variances. At its sole discretion, Developer reserves the right to approve any setback variances, whether for Developer's own construction or otherwise; provided, however, that said variances shall be consistent with applicable zoning provisions.

Section 1.5.7 – Sediment Control. In the construction of improvements on any lot in the Development, no activities or any action will be taken by a grantee of a lot which would be in violation of the NPDES permit for the allotment or a violation of the erosion and sediment control plans and any other relevant plans. A grantee of a lot in the Development of said grantee's employees, agents, successors, or assigns, shall not permit sediment to be discharged on adjoining property, on paved surfaces, or into public storm sewer systems. Copies of all applicable plans are on file in the office of the Developer, at 1201 South Main Street, North Canton, Ohio 44720. The builder or lot owner agrees to submit an individual lot Notice of Intent (NOI) to the Ohio Environmental Protection Agency, General Permit Program, P.O. Box 1049, Columbus, Ohio 43266-1049.

Section 1.6 – Prohibited Activities.

The following uses and activities shall be prohibited in the Development unless specific approval therefore is given by the Developer, its successors and/or assigns, or by the Association at such time that all lots within the Development have sold to individuals or entities other than the Developer, or an entity controlled by the Developer.

Section 1.6.1 – Non-Residential Uses. There shall be no industrial, manufacturing, mining, or commercial agricultural uses of any kind permitted on any lot in the Development. Notwithstanding the foregoing, this restriction shall not prohibit the removal of any soil material in connection with development of the property for its permitted use.

Section 1.6.2 – Animals. Maintaining any animals, other than those normally kept as household pets, shall be prohibited. Household pets shall not be maintained or bred for commercial purposes, or kept in a manner so as to constitute a nuisance or activity prohibited by law. The total number of all dogs and cats in any Living Unit shall not exceed two (2) and only dogs that are of a “non-vicious” breed shall be permitted to be kept in or on any said premises. A “non-vicious” breed of dog is any breed that does not meet with the definition of a “vicious dog” as the same is defined in Revised Code Section 955.11(4)(a)(i) – (iii). Dogs, if permitted, shall not be allowed to remain outside so as to create a nuisance with respect to their barking or howling.

Section 1.6.3 – Outbuildings. There shall be no outbuildings constructed on any lot in the Development. Notwithstanding the foregoing, gazebos shall be permitted in the rear yards of lots, upon review and approval by the Architectural Review Board. Nothing herein shall render it permissible, however, for gazebos to be built within the Limited Common Areas and/or Exclusive Easement Areas (hereinafter defined).

Section 1.6.4 – Swimming Pools. There shall be no above-ground swimming pools except small (48” diameter or less) portable pools for children. Private in-ground pools shall be permitted to the extent that approval is sought and granted by the City of North Canton, the Developer, and/or the Architectural Review Board. All swimming pools, together with adjacent improvements, shall be enclosed by a wall or fence having a minimum height of five feet (5’), in accordance with the then existing North Canton City Zoning Ordinance.

Section 1.6.5 – Basketball Hoops. Basketball hoops are permitted; provided, however, that they shall be located immediately adjacent to the driveway of the Living Unit and they must be permanently placed in the ground. No portable basketball hoops are permitted. Basketball hoops may only be used between the hours of 9 A.M. and 9 P.M.

Section 1.6.6 – Trash. Any containers used in connection with trash or garbage, if placed outside the Living Unit, must be concealed from view and protected from animals. Collection services may pick up trash and garbage at the street, in accordance with the North Canton City Code.

Section 1.6.7 – Temporary Structures. Temporary structures, including, but not limited to, trailers, basement or incomplete houses, tents, shacks, garages or other buildings of any kind shall not be permitted; provided, however, that this restriction shall not prohibit trailers and temporary structures used in connection with the development of the property and Living Units.

Section 1.6.8 – Signs. Erection or maintenance of any signs, billboards or advertising devices of any kind shall not be permitted except (a) signs not larger than ten (10) square feet for offering premises for sale shall be permitted on the premises to be sold (one per lot) and (b) Home Builders and General Contractor signs, not larger than ten (10) square

feet (one per lot) and only until sold. The configuration of home builder and general contracting signs shall be at the sole discretion of the Developer. Nothing herein contained shall limit the Developer's right to place entry signs to the Development or signs designating the existence and location of model homes. The size and design of said signs shall be within the sole discretion of the Developer. Political signs and garage or yard sale signs are strictly prohibited from being placed in the rights of way.

Section 1.6.9 – Nuisances. Nuisances and noxious or offensive activities of any kind are strictly prohibited.

Section 1.6.10 – Storage. Storage of motor homes, campers, travel trailers, trailers of any type, recreational vehicles, commercial trucks and trailers, machinery, equipment, boats and other vehicles is prohibited, unless such is not in view from any street or adjacent Living Unit. Nothing herein contained shall limit use of trucks, trailers, or equipment during construction. Recreational vehicles owned by the homeowner or guests of the homeowner may be parked in the homeowner's driveway for a period of time not to exceed seven (7) calendar days on two (2) separate occasions but shall not exceed fourteen (14) days within any one (1) calendar year.

Section 1.6.11 – Laundry. The hanging of laundry outdoors is not permitted.

Section 1.6.12 – Fences. No fences may be erected or placed on any lot or lots from the front of the Living Unit to the street. In the rear of a lot, fences may be permitted for decorative and aesthetic value, only if allowed by the applicable zoning code and if approved, prior to installation, by the City of North Canton, the Developer, and/or the Architectural Review Board. Wire mesh type fences, including dog kennels, are strictly prohibited in all instances. Any fences approved shall be erected not less than two (2) feet from the property line. A property owner who installs a fence on his lot must do so pursuant to this provision unless more stringent guidelines are required by the City of North Canton Zoning Ordinance. Any fence erected on the lot for the purpose of enclosing a swimming pool shall be constructed in accordance with Section 1.6.4 herein.

Section 1.6.13 – Site Lighting. Site lighting which interferes with the comfort, privacy or general welfare of adjacent or other lot owners is prohibited.

Section. 1.6.14 – Appearance. No unsightly growth shall be permitted to grow or remain upon any lot and no refuse or unsightly objects shall be allowed to be placed or suffered to remain anywhere thereon.

Section 1.6.15 – Satellite Dishes. No satellite dishes shall be permitted, except those less than twenty (20) inches in diameter and not visible from the street. In the event that it is determined that the Federal Communication Commission, pursuant to its rule-making power as set forth at Section 207 of the Telecommunications Act of 1996 has the right to pre-empt this covenant, the maximum sized dish which will be permitted shall be the minimum size dish as provided for by the relevant rule. Also, in such event, the Developer or the Association shall have the right to regulate the location and manner of installation of said dishes. Furthermore, antennas, aerials, or other such devices for television or radio reception are not permitted on the outside of any Living Unit or outbuilding or otherwise on any lots in the Development.

Section 1.6.16 – Subdivision of Lots. No lot in the Development shall be subdivided or divided unless or until the plat showing such proposed subdivision or division shall have been submitted to the Developer or the Architectural Review Board and the written consent of same have been obtained.

Section 1.6.17 – Concrete Block. No split face concrete block is permitted nor shall it be used in place of a brick or stone band in complying with Item 1.9.8 of this Declaration.

Section 1.7 – Submittals and Approvals.

Section 1.7.1 – Entity from whom Approval shall be sought. At such time as all of the lots in the Development have been sold to individuals or entities other than the Developer, or any entity controlled by the Developer, or at such earlier time as the Developer may elect, the right to approve all further construction or other items contained herein shall shift from the Developer to an Architectural Review Board established by the Association (hereinafter referred to as the “Board”), comprised of three (3) lot owners nominated and elected by the majority of the lot owners. The lot owner receiving the most votes will have a three (3) year term. The lot owner receiving the second most votes will have a two (2) year term and the lot owner receiving the third most votes will have a one (1) year term. Thereafter, said Board shall be comprised of said three (3) members or their successors. Nothing herein contained shall be construed as a diminution in the Developer’s authority to appoint an initial Architectural Review Board (also referred to from time to time as the “Board”) to make all reviews and approvals as contemplated herein until the Association’s Board assumes said duties pursuant to the terms hereof or until the Developer relinquishes authority as provided herein above or hereinafter.

Section 1.7.2 – Form of Submittals. All matters herein requiring the approval of the Developer and/or the Board by the terms of this instrument shall be submitted to the Developer and the Board in writing, accompanied by such plans, specifications, details and other documents (hereinafter collectively referred to as the “Plans”), as are reasonably required by it to make a proper decision. In order to ensure that the homes and other buildings will have a uniform high standard of construction, and that the Development will be comprised of high quality custom homes, the Developer and the Board reserve the right, in their sole discretion, to reject all such plans and specifications as aforesaid for any reasonable grounds, including, but not limited to aesthetic reasons. The Developer and the Architectural Review Board shall approve or disapprove such written submission or application for approval in writing. If a lot owner does not receive approval of the submitted Plans, the Developer reserves and shall have the right to re-purchase the lot at the same price and on the same terms from which the original lot owner bought the lot from the Developer.

Section 1.7.3 – Architectural Review Board.

Section 1.7.3.1 – Establishment. The Developer will establish and appoint the Board, to serve until the Developer relinquishes authority and the Association’s Board is appointed by the Association, for the following purposes:

- a. To provide a staff of persons for reviewing, evaluating, approving and disapproving proposed plans;

b. To establish, maintain and preserve specific architectural guidelines and standards to carry out the intent of these Restrictions, which guidelines and standards from time to time in effect with respect to all or any portion of the Property, shall hereinafter be referred to as the "Architectural Guidelines." The Architectural Guidelines are established written guidelines which are hereby incorporated herein and made apart hereof. Every person who now or hereafter owns or acquires any rights, title or estate in any portion of the Development is and shall be conclusively deemed to have actual notice of the Architectural Guidelines which are established written guidelines governing any physical improvements to the lots located within the Development, including but not limited to, structures, fencing, landscaping, garages, plantings, color schemes, building materials, etc. Copies of the Architectural Guidelines are available through the Association or the Developer upon request.

c. To enforce the provisions of these Restrictions.

Section 1.7.3.2 – Board Responsibilities: Effect of Actions. The Board shall exercise its best judgment to see that all improvements in the Development conform to The Sanctuary's Architectural Guidelines and Building Restrictions as to external design, quality and types of construction, materials, colors, setting, height, grade, finished ground elevation, landscape, and tree removal. The actions of the Board, through its approval or disapproval of Plans and other information submitted pursuant hereto, shall be conclusive and binding on all interested parties.

Section 1.7.3.3 – Requirements of Plan Approval. No improvement, change, construction, addition, excavation, landscaping, tree removal or other work or action which in any way alters the exterior appearance of the Development from its theretofore natural or improved state (and no change, alteration or other modification of any of the foregoing previously approved hereunder), shall be commenced or continued until the same have first been approved in writing by the Architectural Review Board or the Developer in accordance with the Architectural Guidelines. Approval shall be required by submission to the Board of Plans, in duplicate, showing (a) through (k) below. Plans shall describe types of construction and exterior materials to be used.

a. Existing and proposed land contours and grades: Developer reserves the right to establish grades and slopes on the lots, Common Areas, Limited Common Areas and Exclusive Easement Areas in the Development and to fix the grade at which any Living Unit shall be constructed or placed, so that grade conforms to the general plan for grade and slope of lots in the Development. The owners of all lots, blocks, open spaces, "Common Areas," "Limited Common Areas" and "Exclusive Easement Areas," (all as defined hereinafter), as the same are set forth on the Plats and herein, shall conform to the Sanctuary No. 1 and No. 2 Grading Plan, Sheet SD-4, on file with the Developer and the North Canton Engineers Office. Further, lot owners are restricted from grading in the "Drainage Easements" (hereinafter defined).

b. All buildings, including Living Units, and other improvements, access drives, and other improved areas and the locations thereof on the site;

- c. All landscaping, including existing and proposed tree locations and planting areas (and specie thereof), and ornamentation;
- d. Plans for all floors, cross sections and elevations, including projections and wing walls;
- e. Exterior lighting plans;
- f. Walls, fencing, and screening;
- g. Patios, decks, pools, and porches;
- h. Parking areas;
- i. Complete exterior color scheme & color samples;
- j. Samples of all major materials to be used;
- k. Such other information, data, drawings as may be reasonably requested by the Board and/or the Developer.

Section 1.7.3.4 – Basis of Approval. Approval shall be based, among other things, upon conformity and harmony of the proposed Plans with the Development's Architectural Guidelines and other structures in the Development; the effect of the location and use of improvements on neighboring property; and conformity of the Plans and specifications to the purpose and general intent of these Restrictions.

Section 1.7.3.5 – Liability Relating to Approvals. Neither the Developer, the Board, nor any member thereof, or any of their respective heirs, personal representatives, successors or assigns, shall be liable to anyone submitting Plans for approval by reason of mistakes in judgment, negligence, or nonfeasance arising out of or in connection with the approval or disapproval or failure to approve any Plans. Every person and entity who submits Plans to the Developer and/or to the Architectural Review Board agrees, by submission of such Plans, that he/she or it will not bring any action or suit against the Architectural Review Board or the Developer in law or equity or to recover any damages and hereby releases the Board and/or the Developer from any future liability or damages associated therewith.

Section 1.7.3.6 – Requirement for Approval. Each individual lot owner or his representative shall submit simultaneously with Plans for approval, a compliance deposit in the amount of Two Thousand Five Hundred Dollars and No/100 (\$2,500.00), and a completed copy of the "Application For Review" checklist, indicating compliance or non-compliance with the building restrictions as listed, and shall furnish reasons for non-compliance on a separate page. This is intended to reduce delays and expedite approval. The Board and/or the Developer shall retain the full amount of the compliance deposit until completion of construction of a Living Unit in full conformity with the approved Plans.

Section 1.8 – Construction.

Section 1.8.1 – Start of Construction. Construction of a Living Unit shall commence within twenty-four (24) months after an individual lot owner takes title to his/her lot. In the event construction has not commenced within the first twenty-four (24) months, the Developer reserves the right to re-purchase the lot from its owner at the same price and on the same terms from which the original owner acquired it from the Developer.

Section 1.8.2 – Requirements of Completion. Construction shall be completed no later than twelve (12) months after construction has commenced. Landscaping shall be completed no later than six (6) months after completion of construction.

Section 1.8.3 – Upkeep prior to Commencement of Construction. Residential lots purchased, but on which construction has not commenced, must be mowed not less than once every thirty (30) days during the growing season and must have the sidewalk installed not later than the time at which an adjacent lot owner installs their sidewalk; provided, however, that the sidewalk need not be installed within this time frame in cases where the Developer exercises its option to re-purchase the lot from its owner.

Section 1.9 – Design Standards and Building Restrictions.

Section 1.9.1 – Sloped Lots. Living Units should fit into sloped lots as much as possible. Stepped plan arrangements are encouraged to minimize cut and fill in these areas.

Section 1.9.2 – Retaining Walls. Retaining walls in cut situations are permitted and shall be constructed per the Architectural Guidelines.

Section 1.9.3 – Wooded Lots. The rear yard on wooded lots must remain as much as possible in its natural state. Clearing for decks and patios, however, may be permitted.

Section 1.9.4 – Decks and Patios. Decks and patios shall not be permitted in the front yard unless approved by the Developer or the Architectural Review Board.

Section 1.9.5 – Garage Location. Garage location shall be determined by the Developer or the Architectural Review Board and garage doors shall be of one color.

Section 1.9.6 – Lights. Yard and security lights shall be of a design approved by the Developer or the Architectural Review Board. Emergency flood lights for security are permitted provided they are located so as to not disturb adjacent owners.

Section 1.9.7 – Roof Vents. No vents shall be placed on the “front” half (50%) of the roof area, regardless of roof slope or shape. Flashing and vents shall be painted the same color as the roof.

Section 1.9.8 – Foundation. No exposed concrete block foundation, including split face concrete block, shall be permitted. A brick band is required on all sides. On walkout basements, the brick band shall be installed from ground level to the first floor, floor joists.

Section 1.9.10 – Mailboxes. Mailboxes and newspaper boxes will be provided and installed by the Developer. Mailbox location will be determined by the United States

Postal Service. Mailboxes and newspaper boxes, once installed, shall be maintained by the lot owner. No mailbox or newspaper delivery receptacle shall be erected and/or maintained other than the type approved and installed by the Developer.

Section 1.9.11 – Roofs. Roofs shall have a minimum pitch of 8/12 with asphalt dimensional shingles or other approved high quality roofing products.

Section 1.9.12 – Cable. Each Living Unit is to be pre-wired for cable TV. Cable TV will be provided underground adjoining each lot.

Section 1.9.13 – Colors. No more than two (2) main wall colors and two (2) main materials on any building are permitted unless approved in writing by the Developer or the Architectural Review Board.

Section 1.9.14 – Landscaping. A minimum of three (3) trees, at least 1-1/2” trunk diameter, per unit are required on non-wooded lots, in addition to trees provided by Developer along streets. Proposed trees and tree locations must be shown on the site plan.

Section 1.9.15 – Repetition. Lot owners should select building sites and plans so as not to attempt to construct repetitious designs within close proximity. Furthermore, careful consideration must be given to roof lines of adjacent Living Units. An early discussion before design is encouraged if owners have any question about approval regarding this point.

Section 1.9.16 – Repainting. Repainting of an existing Living Unit with a color other than previously approved shall require approval of the Developer or the Architectural Review Board.

Section 1.9.17 – Emergency Phone. All builders are required to keep on record with the Developer a 24 hour emergency phone number.

Section 1.9.18 – Materials, Details & Directions. It is a requirement that the major design element on the front elevation be brick or stone.

Section 1.9.18.1 – Building Materials. All materials used (i.e. roofs, walls, etc.) shall be compatible with each other and blend together with a common tone. Accent colors are acceptable if used carefully to add detail and highlight architectural features. The following materials are acceptable for use in the Development:

- a. Wood Siding: Four (4) and eight (8) inch clapboard, rough or smooth finish; channel rustic boards; v-joint tongue and groove boards, vertical board and batten; wood shingles; all with semi-transparent stains are recommended. Paint is allowed, but does require more maintenance than stain and is not considered as desirable as stain.
- b. Vinyl or Aluminum Siding: Vinyl siding is preferred. Aluminum siding is not permitted without prior written approval of the Developer or the Architectural Review Board.

- c. Brick: Natural sand molded brick is preferred. "Manufactured" sand mold and textured brick may also be used. Color ranges should be subtle with no dark brown, speckled or glazed brick permitted, unless otherwise approved by the Board or the Developer. Brick detail in chimneys, sills, entry steps and foundations are encouraged. Exposed single depth of brick or stone at building corners is not permitted.
- d. Stone: Cultured stone laid in a natural horizontal bed is preferred. Rubble and roughly squared stone is felt to be aesthetically more pleasing because of its natural quality than square cut dimensional or ashlar stone. Native Ohio limestone in gray or buff is recommended over more exotic stone.
- e. Stucco: Natural, hand finished, or sand textured finishes are preferred; scratches, splashes and artificial textures are discouraged. Stucco colors must blend with other colors. White stucco is discouraged.
- f. Other Materials: Use of other man-made materials is permitted if they are painted to blend with other natural materials. The use of wrought iron and other decorative ornamentation must be approved by the Architectural Review Board and/or the Developer.

Section 1.9.19 – Facades. All sides of a Living Unit should be finished with the same materials, or with compatible materials that blend with one another. Termination of masonry front facade materials shall be at inside building corners and at second floor roof overhangs. Where front facade masonry turns an outside corner to the side of the Living Unit, masonry must continue to the next break in the building facade; rear corner of side wall; or terminate to a carefully designed detail of architectural element (faux column, window bay, etc.) as approved by the Architectural Review Board.

Section 1.9.20 – Windows. Windows should be carefully selected and proportioned to enhance walls in which they are placed. Windows are required on all major walls including walls facing side yards.

Section 1.9.21 – Chimneys. Brick or stone masonry exterior construction is required. Exposed pre-fab fireplace flues, vinyl sided chases, and bump-out chimneys are prohibited on all elevations. All fireplaces shall have a masonry foundation. A through the wall vent is permitted on the rear elevation only.

Section 1.9.22 – Sidewalks. Lot owners or their assigns shall, within three (3) months of occupancy of their Living Units, construct on their lot a sidewalk which shall be four feet (4') wide, four inches (4") deep, constructed of concrete (six sack limestone mix) and meet with the specifications of the applicable City of North Canton Ordinances and/or Regulations, and shall span the width of the lot and connect with the sidewalk constructed on adjoining lots on each side of the premises. Any lot owner whose lot has an Exclusive Easement Area associated with it, which Exclusive Easement Area abuts a dedicated roadway, shall be responsible for constructing a sidewalk upon such Exclusive Easement Area, at its sole cost and expense, in accordance with this Section 1.9.22.

Section 1.9.23 – 100-year Floodplain Requirements. The following lots are restricted to an allowable lowest floor elevation due to the 100-year floodplain: 98, 99, 100, 101, 102, 103, 104, 105, 106, 107, 113, 114, 115 & 119, as the same is set forth on the Plats for the Development. The Developer shall provide a benchmark elevation at the location of these lots upon request.

Section 1.10 – Streetlights.

Section 1.10.1 – Installation/Operation/Cost. The Developer shall provide streetlights. The cost of operation and maintenance of the lights shall be shared equally by lot owners and such costs shall be assessed as provided in Article V, Assessments, or as otherwise provided for by the City of North Canton.

ARTICLE II

RESERVATIONS AND EASEMENTS

Section 2.1 – Developer’s Right to Add Additional Land.

The Developer reserves unto itself and its successors and/or assigns, the right to add any and all property contiguous to the Development currently zoned R-50 and R-70, together with that land zoned RMFA and FMFB, to the Association; provided, however, that same or similar Restrictions shall be imposed upon said additional lands. The Association shall be an Ohio not-for-profit corporation. It is intended to be a Master Association for the Development property and any adjacent property, the owners of which shall be bound by the Association’s rules and regulations.

Section 2.2 – Future Easement Rights.

The Developer reserves unto itself and its successors and/or assigns, the right to petition for or grant future easement or rights of way for the construction, maintenance, extension and operation of all public or private utility facilities in or upon all highways and streets, now and existing or hereafter established, upon which any portion of the Development may now or hereafter front or abut. The owners of any and all lots of the Development agree to and do hereby consent to and affirm all such agreements that may be entered into between the Developer and public or private utility companies, entities or authorities.

Section 2.3 – Utility Easements.

Section 2.3.1 – Platted Easements. As provided for in the Plats, each lot in the Development shall be subject to a five foot (5’) wide easement on the side of each lot as it abuts adjacent lots and a twelve (12.00) foot wide easement at the front of each lot, being parallel with and contiguous to the streets and/or highways within or adjacent to this Development, excluding Applegrove St., N.W., for AEP, SBC Ohio, Utility Pipelines, Ltd., Time Warner Cable, and Aqua Ohio, to be used for installing, operating, maintaining and servicing of pole lines, underground cables and conduits. The character of the installation and structures which may be constructed, reconstructed, removed and maintained in, on, and through these easements shall include all incidental appurtenances such as guys, conduits, poles, anchors, transformers, pad mounted transformers, pads, handholes, etc. Said easement rights shall include the right, without liability therefore, to remove trees and landscaping including lawns, flowers or shrubbery within said easement premises which may interfere with the installation, maintenance, repair or operation of electric current, and the right of access,

ingress to and from any of the within premises, for exercising any of the purposes of this right of way and easement.

Section 2.3.2 – Relocation of Utility Easements. The Developer reserves unto itself, its successors and/or assigns, the right to relocate utility easements in accordance with the requirements of Stark County, the City of North Canton, or as otherwise necessary for the orderly development of the Development.

Section 2.4 – Maintenance and Development Easements.

The Developer reserves the right for itself, its agents, employees, successors and assigns, to enter upon any lot for the purpose of carrying out and completing the development of the property, including but not limited to the completion of any dredging, filling, grading or installation of drainage facilities, including “Drainage Easements” (hereinafter defined) and/or a major storm spillway. Developer further reserves the right for itself, its agents, employees, successors and/or assigns to enter upon any lot for the purpose of carrying out and completing the development of the property, including, but not limited to, the creation and maintenance of a natural visual buffer within a 20 foot (20’) wide strip, along portions of the east, west and south property lines of the Development. Finally, Developer reserves the right for itself, its agents, employees, successors and/or assigns to enter upon any Limited Common Area and/or Exclusive Easement Area (both hereinafter defined) for the purpose of carrying out any of its obligations created in the Declaration or the within Amendment, including, but not limited to, maintenance and upkeep of the ponds located within the Development. Entry onto said property for the purposes contemplated herein shall not be deemed a trespass.

Section 2.5 – Drainage Easements.

Section 2.5.1 – Platted Easements. Each lot in the Development shall be subject to the Sanitary Sewer Easements, Storm Sewer Easements, Public Drainage Easements and Public Drainage Path Easements delineated on the Plats. By the City of North Canton accepting the aforementioned easements, lot owners shall not place or cause to have placed within the easement areas, any fences, landscaping trees, driveways, walks, structures or alter the ground elevation in any way. Should any of the above-mentioned occur, the City shall have the right to remove these items without compensation to the lot owner(s). The City shall only be responsible to re-seed disturbed easement areas as described in the most recent edition of the State of Ohio, Department of Transportation, Construction and Materials Specifications, Item 659 “Seeding and Mulching.”

Section 2.5.2 – Lot Perimeter Easements. Each lot in the Development shall have a seven and one-half foot (7.5’) easement located around its perimeter for purposes of promoting drainage within the Development. The Developer and/or a subsequently formed Association shall enforce proper maintenance, repair, operation, and control of such drainage easements by the lot owners, at the lot owner’s sole cost and expense.

Section 2.5.3 – Mound Piping Easements. Easements are hereby created over the Development for the purposes of installing, maintaining, repairing and replacing mound piping, as the same is set forth on the Plats, which mound piping easements are intended to promote drainage within the Development. It shall be the obligation of the Developer and/or a subsequently formed Association to properly maintain, repair, operate and control

such easements unless they are accepted by the City of North Canton or another governmental entity having jurisdiction thereof.

Section 2.6 – Easements for common areas, facilities and elements.

The Developer has provided for and conveyed or will convey to the Association easements to maintain the areas around the entrance signs, fencing, mounding and boulevard entrances to the various phases of the Development. The Developer has also conveyed or will convey to the Association the ponds, clubhouse and pool, landscape islands, walking paths, open space located around the entrance to the Development, Common Areas, Limited Common Areas, Exclusive Easement Areas (all as hereafter defined), and the easement to Stark Parks District for its walking path in and around the Common Areas. Upon designation by the Developer of any part of the Development owned by it as Common Areas, Limited Common Areas and/or Exclusive Easement Areas, the Developer shall cause a plat, showing those areas so designated, easement, deed or a declaration stating that such land has been so designated to be recorded among the records of the Recorder of Stark County. No part of the Development shall be considered part of the Common Areas, Limited Common Areas and/or Exclusive Easement Areas, subject to the rights and easements of enjoyment and privileges hereinafter granted, unless and until the same shall have been so designated and the above described plat easement, deed or declaration filed in accordance with the foregoing procedures. Common Areas, Limited Common Areas and Exclusive Easement Areas shall remain such in perpetuity, subject only to the provisions of Article III.

Section 2.7 – Landscape Easements.

The Developer and/or a subsequently formed Association shall be fully responsible for the maintenance, upkeep and repair of the entrance amenity landscape areas, open space and the cul-de-sac island landscape areas, as shown within the “Landscape Easements” set forth on the Plats and the retention basins constructed and to be maintained within the “Public Drainage Easements” also set forth on the Plats. The Landscape Easements and the Public Drainage Easements are included as Common Areas as described in the within Declaration, and as may be amended from time to time and recorded with the Stark County Recorder and the costs and expenses associated with said maintenance, upkeep and repair shall be deemed Amenity Landscape Expenses and Detention Basin Expenses. The Association shall hold the City of North Canton harmless and shall indemnify said City for any and all liability it may incur as a result of the creation and continued existence of the Landscape Easements set forth on the Plats.

ARTICLE III

COMMON AREAS, LIMITED COMMON AREAS & EXCLUSIVE EASEMENT AREAS

Section 3.1 – Establishment of common areas, facilities and elements.

Developer desires to create within the Development three designations of common areas, facilities and elements, which will include, without limitation, boulevards, landscape islands, entrance signs, open space, ponds, walking paths, a clubhouse and pool. The commons areas, facilities and elements shall be classified as (i) “Common Area,” to be held for the benefit and use of the Development and each subsequent lot owner thereof or a portion thereof; (ii) “Limited Common Area,” to be held for the benefit and use of a designated group of lot owners; or (iii) “Exclusive Easement Area,” to be held for the benefit and use of a single designated lot owner. The Common Areas, Limited Common Areas and Exclusive Easement Areas are designated on

the Plats for the Development and Exhibits A, B, C and D attached hereto and by this reference incorporated herein.

Section 3.2 – Use of common areas, facilities and elements.

Each individual owner of a lot in the Development, by virtue of being an owner, has the right, privilege, and benefit of use of the Development's Common Areas.

Each individual owner of a lot in the Development whose lot has Limited Common Area associated with it, as shown on the attached Exhibits, by virtue of being an owner of such lot, has the right, privilege, and benefit of use of such Limited Common Area.

Each individual owner of a lot in the Development whose lot has an Exclusive Easement Area associated with it, as shown on the attached Exhibits, by virtue of being an owner of such lot, has the right, privilege, and benefit of use of such Exclusive Easement Area. The amount of Exclusive Easement Area accruing to each lot owner affected hereby is set forth in the table attached hereto as Exhibit "E" and by this reference incorporated herein. Notwithstanding the Developer's right to insure portions of the Development that it owns, each lot owner who receives an Exclusive Easement Area hereunder shall be responsible for maintaining insurance on his/her/their Exclusive Easement Area and agrees to indemnify, save and hold Developer harmless from any/all loss, injury or damages occurring as a result of the use of Exclusive Easement Area(s).

The rights provided for herein are not assignable unto third parties and terminate when a lot owner conveys his interest in a lot to another Grantee.

Section 3.3 – Authority to Convey common areas, facilities and elements.

Notwithstanding the rights, easements and privileges granted hereunder, the Association shall nevertheless have the power and authority to convey or dedicate any property or easement or right-of-way over the Common Areas, Limited Common Areas or Exclusive Easement Areas, free and clear of all such rights, easements and privileges if such conveyance or dedication is for use as a public roadway or pedestrian walkway, or to a public or private utility for the installation, operation and maintenance of utility services. Any other conveyance or dedication of the Commons Areas, Limited Common Areas or Exclusive Easement Areas shall be made only for a public purpose, and, if made for a purpose other than those specified in the immediately preceding sentence of this paragraph, only by an affirmative writing signed by at least two-thirds (2/3) of the lot owners who are entitled to use such areas.

Section 3.4 – Alterations to and Maintenance of the common areas, facilities and elements.

All alterations, landscaping and maintenance of the Common Areas, including, but not limited to, installation of any improvements, construction of any building or structure, planting, trimming, or maintenance of any landscaping, lawn or trees, shall be made or done solely by or at the direction of the Association (or the Developer, prior to the conveyance of the Common Areas to the Association), and no such alterations, landscaping and/or maintenance shall be permitted to be completed by any lot owner or occupant.

The Limited Common Areas are being dedicated in their "as-is" condition. Each lot owners whose lot is associated with a Limited Common Area shall landscape it with grass and be

responsible for sharing in its maintenance at a level commensurate with a majority of the lawns in the Development, with each lot owner to be responsible for that portion of the Limited Common Area that directly adjoins his/her lot. Any/all alterations to the Limited Common Areas, including, but not limited to, installation of any improvements or construction of any building or structure, shall be made or done solely by or at the direction of the Association (or the Developer, prior to the conveyance of the Limited Common Areas to the Association), and no such alterations shall be permitted to be completed by any lot owner or occupant.

The Exclusive Easement Areas are being dedicated in their "as-is" condition. Each lot owner whose lot is associated with an Exclusive Easement Area shall landscape it with grass and be responsible for maintaining it at a level commensurate with a majority of the lawns in the Development. Any/all alterations to the Exclusive Easement Areas, including, but not limited to, installation of any improvements or construction of any building or structure, shall be made or done solely by or at the direction of the Association (or the Developer, prior to the conveyance of the Exclusive Easement Areas to the Association), and no such alterations shall be permitted to be completed by any lot owner or occupant. Notwithstanding the foregoing, fences shall be permitted in the Exclusive Easement Areas to within fifteen (15) feet of the water's edge, in accordance with Section 1.6.12 herein.

Section 3.5 – Authority to Borrow Funds.

The Association shall have the power and authority to borrow money for the purpose of improving the Common Areas, Limited Common Areas and Exclusive Easement Areas and in aid thereof, to mortgage the same, and the rights of any such mortgages shall be superior to the easements and privileges herein granted and assured.

Section 3.6 – Stark Parks Walking Trails.

The Developer and/or the Association reserve the right to convey in fee or grant an easement for a portion of the Development to Stark County Park District, an Ohio political subdivision, along the east and north sides of the Development, and also along the creek through the middle of the Development, for the purpose of establishing walking trails in, through and upon the Development. A portion of the Stark Parks trail is designated on Exhibits B, C and D attached hereto.

ARTICLE IV

THE ASSOCIATION

Section 4.1 – Existence, Membership and Voting Rights.

The Association is an Ohio not-for-profit corporation. It is intended to be a Master Association for the Development property and any adjacent property, the owners of which shall be bound by the Association's rules and regulations. The Developer hereby reserves unto itself and its successors and/or assigns, the right to add any and all property contiguous to the Development currently zoned R-50 and R-70, together with that land zoned RMFA and FMFB, to the Association; provided, however, that same or similar Restrictions shall be imposed upon said additional lands. The membership of the Association is and shall be divided into two (2) classes as follows:

Section 4.1.1 – Class “A” Membership and Voting Rights. Each owner of a lot, with the exception of the Developer, shall automatically be Class “A” Members of the Association. All lot owners shall be Members of the Association. Class “A” Members shall be entitled to one (1) vote per lot in which they hold the fee simple interest or interests. In any situation where a Class “A” Member is entitled to exercise a vote and more than one (1) person holds the interest in such lot, the vote for such lot shall be exercised as those persons determine among themselves and advise the Secretary of the Association in writing prior to any meeting. In the absence of such advice, the vote of the lot shall be suspended if more than one (1) person seeks to exercise it. In the case of a lot owned or held in the name of a corporation, partnership, limited partnership, limited liability company, trust or other entity, a certificate signed by such owner shall be filed with the Secretary of the Association naming the person authorized to cast a vote for such lot, which certificate shall be conclusive until a subsequent certificate is filed with the Secretary of Association. Notwithstanding the foregoing, once a lot owner builds a Living Unit on more than one lot, he/she/it will be entitled to only one (1) vote.

Section 4.1.2 – Class “B” Membership and Voting Rights. The Developer shall automatically be the sole Class “B” Member of the Association. The Class “B” Member shall be entitled to three (3) votes for each lot owned by it. The Class “B” Membership shall cease and be converted to Class “A” Membership upon the sale and/or transfer of the last lot owned by the Developer in the Development.

Section 4.2 – Boards and Officers of the Association.

The Directors of the Board and the Officers of the Association shall be elected as provided in the Code of Regulations of the Association (the “Code”) and shall exercise the powers, discharge the duties and be vested with the rights conferred by operation of law, the Articles and Code, except as otherwise specifically provided.

Section 4.3 – Rights of the Association.

Notwithstanding the rights and easement of enjoyment and use created in Article II of the Declaration, and in addition to any right the Association shall have pursuant to this Declaration, the Code, or in law, the Association shall have the right:

- a. To borrow money from time to time for the purpose of improving the Common Areas, Limited Common Areas and Exclusive Easement Areas, and, with the assent of two-thirds (2/3) of each class of Members, secure said financing with a mortgage or mortgages upon all or any portion of property owned by the Association in accordance with its Articles and Code and subject to the provisions of this Declaration.
- b. To take such steps as are reasonably necessary to protect the Common Areas, Limited Common Areas and Exclusive Easement Areas from foreclosure.
- c. To convey the Common Areas, Limited Common Areas, or Exclusive Easement Areas, or a portion thereof, to a successor; provided, however, that any such conveyances shall require the vote of two-thirds (2/3) of each of the Class “A” and Class “B” Members, and provided further that such successor shall agree, in

writing, to be bound by the easements, covenants, restrictions and agreements of this Declaration.

- d. To enter or authorize its agents to enter on or upon the Development, or any part thereof, when necessary in connection with any maintenance, repair or construction for which the Association is responsible or has a right to maintain, repair or construct.
- e. To grant or obtain or dedicate to public use, easements and rights-of-way: (i) for access and easements for the construction, extension, installation, maintenance or replacement of utility services and facilities, or (ii) to or from a public or governmental authority, and to or from any body or agency which has the power of eminent domain or condemnation over any portion of the Property; provided, however, that no such dedication or transfer shall be effective unless an instrument agreeing to such dedication or transfer be signed by two-thirds (2/3) of the Members has been recorded.

Section 4.4 – Responsibilities of the Association.

Section 4.4.1 – Maintenance of the common areas, facilities and elements. The Association shall maintain the Common Areas in a clean, safe, neat, healthy and workable condition, and in good repair, and shall promptly make all necessary repairs and replacements, structural and non-structure, ordinary as well as extraordinary, subject only to the provisions of this Declaration. The Association may provide equipment and supplies necessary for the maintenance (including landscape maintenance) and enjoyment of the Common Areas. All work performed by the Association under this Article shall be performed in a good and workmanlike manner. The Association shall maintain in perpetuity all landscape screening installed within the Common Areas adjacent to Applegrove St., N.W., in an attractive and healthy condition, and shall replace all diseased or dying plant material with similar plant stock. The Association shall pay all taxes, utilities and insurance premiums related to its ownership and operation, if applicable, of the Common Areas, Limited Common Areas and Exclusive Easement Areas. The Association shall obtain and maintain a comprehensive policy of public liability insurance covering all of the Common Areas, Limited Common Areas and Exclusive Easement Areas, insuring the Association, the Board, and lot owners, with such limits as the Board may determine (provided, that such coverage shall be for at least \$1,000,000.00 per occurrence, for personal injury and property damage), covering claims for personal injury and/or property damage. The Association shall have the authority to and shall obtain insurance for all improvements, buildings and structures now or at any time hereafter owned by the Association, against loss or damage by fire, lightning, and such other hazards as are ordinarily insured against in fire and extended coverage policies issued in the locale of the Development, in amounts not less than one hundred percent (100%) of the insurable value of such improvements (based upon replacement cost).

Section 4.4.2 – Management. The Association will provide the management and supervision for the operation of the Common Areas and guidelines for the operation of the Limited Common Areas and Exclusive Easement Areas. The Association shall establish and maintain such policies, programs and procedures, and shall perform and carry out all other duties and acts reasonably necessary to give effect to and to fully

implement this Declaration for the purposes intended and for the benefit of the members and may, but shall not be required to:

- a. Adopt rules and regulations;
- b. Engage employees and agents, including without limitation, security personnel, attorneys, accountants and consultants, maintenance firms and contractors; and
- c. Delegate all or any portion of its authority and responsibilities to a manager, managing agent, or management company. Such delegation may be evidenced by a management contract which shall provide for the duties to be performed by the managing agent and for the payment to the managing agent of a reasonable compensation.

Section 4.4.3 – Rules and Regulations. The Association may make and enforce rules governing the Commons Areas, Limited Common Areas and Exclusive Easement Areas, which rules shall be consistent with the rights and duties established by this Declaration. Such rules shall apply to all owners, and their family members, guests, tenants and other occupants and the Association may sanction lot owners for violation by any such persons. Sanctions may include reasonable monetary fines and suspension of the right to vote. The Board shall, in addition, have the power to seek relief in any court for violations or to abate nuisances. Imposition of sanctions shall be as provided in the Code of the Association.

Section 4.4.4 – Developer’s Rights. During the period of existence of Class “B” Membership, the Developer may, but shall not be obligated to, exercise all or any of the powers, rights, duties and functions of the Association, including, without limitation, the right to levy special assessments as authorized herein, the right to enter into a management contract, the right to obtain insurance under Developer’s blanket policy (if any), the right to perform each duty and obligation of the Association set forth herein, the right to collect assessments and disburse all funds of the Association, and the right to have a lien (and to foreclose said lien) on a Living Unit for unpaid assessments in the manner and to the extent granted to the Association as herein provided. Notwithstanding any other provision in this Declaration or the Code to the contrary, Developer, in Developer’s sole discretion, may turn over control of the Association to the Class “A” Members (hereinafter defined as the “Turnover Date” here and in the Code) at any time prior to the expiration of the Class “B” Membership as set forth in Section 4.1.2 above. Further, notwithstanding any other provision in this Declaration or the Code to the contrary, Developer, in Developer’s sole discretion, may retain control of the Association and not turn over control, administration and/or governance of the same to Class “A” Members until expiration of the Class “B” Membership as set forth in Section 4.1.2 above.

ARTICLE V

ASSOCIATION ASSESSMENTS AND FEES

Section 5.1 – Definition of Assessments.

As used in this Declaration, “Assessments” shall mean all of the costs and expenses incurred by the Association in the exercise of its obligations with respect to the Common Areas, Limited Common Areas and Exclusive Easement Areas, including, without limitation:

- a. All expenditures required to fulfill the responsibilities of the Association, including, but not limited to, expenditures relating to maintenance and insurance;
- b. All amounts associated with the Landscape Expenses and Detention Basin Expenses as the same are discussed in more detail at Item 2.6 of the within Declaration;
- c. All amounts incurred in collecting Assessments including all legal and accounting fees;
- d. Reserves for uncollectible Assessments, unanticipated expenses, replacements, major repairs and contingencies;
- e. Annual capital additions and improvements and/or capital acquisitions (but not repairs or replacements) having a total cost in excess of Five Thousand and Dollars and No/100 (\$5,000.00), without in each case the prior approval of the Class "B" Member and the vote of at least two-thirds (2/3) of the Class "A" Members who are voting in person or by proxy, at a meeting duly called for his purpose. In case of an emergency requiring prompt action to avoid further loss, the Board shall have the discretion to expend whatever is necessary to mitigate such loss.
- f. Such other costs, charges, and expenses which the Association determines to be necessary and appropriate within the meaning and spirit of this Declaration.

Section 5.2 – Applicability.

All lot owners shall be members of the Association and shall be bound by all of the rules and regulations that may be established by its governing body.

Section 5.3 – Creation of Lien and Personal Obligation of Assessments.

Each owner of a lot, by acceptance of a deed therefore, whether or not it shall be so expressed in such deed, is deemed to covenant and agrees to pay to the Association: (1) annual Assessments or charges; (2) special Assessments for capital improvements; and (3) additional Assessments, all such Assessments to be established and collected as hereinafter provided. Each such Assessment, together with interest, costs and reasonable attorney's fees, shall also be the personal obligation of the person who was the owner of such lot at the time when the Assessment fell due. The personal obligation for delinquent Assessments shall not pass to his successors in title unless expressly assumed by them. Developer shall not have an obligation to pay Assessments for any lots it owns in the Development.. As further provided in the Code, payment of the Assessments for a lot shall not commence until the earlier of (i) transfer of title of such lot to the owner by the builder of the Living Unit; or (ii) the occupancy of a Living Unit as a residence, whether occupied by the builder or a third party. Notwithstanding anything to the contrary hereinabove, an owner of two (2) or more lots in the Development, upon which only one (1) Living Unit has been constructed, shall only be responsible for payment of one (1) Assessment for each category listed above.

Section 5.4 – Purpose of Assessments.

For the purposes of providing funds for the operation, administration, development, maintenance, insurance and upkeep of the Common Areas, Limited Common Areas and

Exclusive Easement Areas, as applicable, the subdivision entrance walls and signs, and fences, the Association shall fix and assess a yearly assessment against each lot owner in the Development. In making such assessment, the Association shall allocate a fair pro-rated share to each of the phases within the Development. The annual Assessment for each of the phases of the Development shall be divided equally among and assessed equally against each lot or proposed lot within the particular phase.

Section 5.5 – Special Assessments.

In addition to annual Assessments authorized herein, the Association may levy in any Assessment year, a special Assessment applicable to that year only for the purpose of defraying, in whole or in part, the cost of any construction, reconstruction, repair or replacement of a capital improvement upon the Common Areas, Limited Common Areas and/or Exclusive Easement Areas, including fixtures and personal property related thereto, and/or to meet any other emergency or unforeseen expenses of the Association, provided that any such special Assessment shall have the assent of two-thirds (2/3) of the votes of each class of Members who are voting in person or by proxy at a meeting duly called for his purpose.

Section 5.6 – Uniform Rate of Assessments.

Both annual and special Assessments must be fixed at a uniform rate for all lots and may be collected on a monthly basis or other periodic basis not more often than monthly or less often than annually.

Section 5.7 – Payment of Assessments.

As soon as practicable in each year, the Association shall send a written statement to each lot owner which sets forth the amount of the annual Assessment and stating the terms of the total sum due and owing. The annual Assessment may be billed, however, in annual, semi-annual, quarterly or monthly installments, as the Association shall in its sole discretion determine, and shall be due within ten (10) days of receipt.

Section 5.8 – Effect of Nonpayment of Assessments; Remedies of the Association.

Any Assessment not paid within thirty (30) days after the due date shall bear interest from the due date at the rate set by the Association and shall be subject to the remedies available to the Association as set forth in this Declaration. In addition, the Association may bring an action at law against the owner personally obligated to pay the same, or foreclose the lien against the owner's lot.

Section 5.9 – No Exemption for Non-Use of Facilities; No Refund of Reserves.

A lot owner may not exempt himself from liability for his monetary and non-monetary obligations created hereunder, including, without limitation, Assessments levied against him, by waiver of the use of the Common Areas, Limited Common Areas, and/or Exclusive Easement Areas owned by the Association or by abandonment of his lot. Furthermore, no lots shall be entitled to any portion of the funds held for reserves, nor shall any owner have a claim against the Association with respect thereto.

Section 5.10 – Initial Contribution.

As further provided herein and in the Code, payment of the Assessments for a lot shall commence upon the transfer of title of such lot to the owner, whether it be a builder or the person intending to occupy the Living Unit upon such lot as a primary residence. In addition to pro-rated Assessments due for the month in which an owner closes upon the acquisition of their lot or the Living Unit is occupied for residential purposes, owners shall also be required to pay a non-refundable initial working capital contribution to the Association at the closing upon the purchase of their lot. Such initial working capital contribution shall be in an amount established by the Developer and shall not be refundable to the owner or any party for any reason, including, without limitation, upon the re-sale of the lot. Developer shall not be required to pay such initial working capital contribution for lots it owns in the Development. The initial working capital contribution collected hereunder may be utilized for any purpose that Assessments may otherwise be utilized by the Association.

ARTICLE VI

LIENS

Section 6.1 – Perfection of Lien.

If any owner shall fail to pay any Assessment levied in accordance with this Declaration (hereinafter referred to as the “Delinquent Owner”) when due and such Assessment is delinquent, or if an owner shall violate any rule or breach any restriction, covenant, or provision contained in the Declaration or Code (hereinafter referred to as the “Violating Owner”), the Board may authorize the perfection of a lien on the ownership interest of the Delinquent Owner and/or the Violating Owner by filing for record with the Recorder of Stark County, Ohio, a Certificate of Lien. The Certificate of Lien shall be in recordable form and shall include the name of the Delinquent Owner and/or the Violating Owner, a description of the ownership interest of the Delinquent Owner and/or the Violating Owner, the entire amount claimed for the delinquency and/or violation, including interest thereon and the costs of collection, and a statement referring to the provisions of this Declaration authorizing the Certificate of Lien.

Section 6.2 – No Waiver Implied.

The creation of a lien upon an ownership interest owned by a Delinquent Owner and/or a Violating Owner shall not constitute a waiver, nor shall it preclude or prejudice the Developer and/or the Association from pursuing any and all other remedies granted to it elsewhere in this Declaration, whether at law or in equity.

Section 6.3 – Personal Obligations.

The obligations created pursuant to this Article VI shall be and remain the personal obligation of the Delinquent Owner and/or the Violating Owner until fully paid, discharged or abated and shall be binding on their heirs, personal representatives, successors and/or assigns.

ARTICLE VII

GENERAL PROVISIONS

Section 7.1 – Limits, Modifications and Enforceability.

Section 7.1.1 – Modification. The Developer reserves for itself, its successors and assigns, the right to amend, change, cancel or add to any or all of the aforementioned provisions when it deems such course of action advisable; provided, however, that no amendment, change, cancellation or addition shall be made unless an appropriate instrument signed by owners of two thirds of the lots within the Development agree to such amendment, change, cancellation or addition. The Restrictions contained herein shall be deemed as covenants running with the land, and shall be binding upon and inure to the benefit of the Developer, the Association, and the respective grantees in deeds for such real estate, their respective successors, purchasers, heirs, executors, administrators and assigns.

Section 7.1.2 – Hardship. If by reason of the shape, dimension, or topography, of any lot or for any other reason satisfactory to the Developer, the enforcement of the provision of these Restrictions would work a hardship, the Developer may modify or grant a variance from such provisions. Such modification or variance may be granted by the Developer if such modification or variance will not do material damage to any adjacent lot or property. Requests for modifications or variances must be submitted to the Developer in writing with the sufficient plans, specifications, and evidence required or requested by the Developer to render a modification. Construction or improvement shall not commence until written approval is granted by the Developer.

Section 7.1.3 – Enforceability. The provisions herein shall run in favor of and shall be enforceable by any person or entity, and the heirs, assigns and successors for such person or entity, who is or becomes an owner of any lot in the Development as well as the Developer, its successors or assigns. It is understood and agreed that all of the foregoing are part of a common and general plan for the development of the Development and the protection of all present and future owners of any part of the Development. Failure of the Developer to enforce any of the restrictions contained herein, shall in no event be construed to be in any manner a waiver of, acquiescence in, or consent to a further or succeeding violation of these Restrictions. However, the failure, refusal or neglect of the Developer, its successors or assigns, to enforce these Restrictions or to prevent violations thereof shall in no event make the Developer, its successors or assigns, liable for such failure, refusal or neglect.

Section 7.2 – Interpretation and Severability.

In case of uncertainty as to the meaning of any article, paragraph, sentence, clause, phrase or word in these Restrictions, the interpretation by the Developer shall be final and conclusive upon all interested parties, including the Association. Subject to the foregoing sentence, in case of uncertainty as to the meaning of any article, sentence, clause, phrase or word in these Restrictions, the interpretation by the Association shall be final and conclusive upon all interested parties, except the Developer. Further, determination by any appropriate authority or court that any paragraph or provision of the Restrictions is invalid or unenforceable shall in no way limit or restrict the validity and enforceability of any other paragraph or provision.

Section 7.3 – Period of Duration.

These Restrictions, and the charges and liens provided for herein, shall be deemed to run with the land; shall continue in full force and effect for a period of fifty (50) years from the date hereof; and shall be automatically reinstated for a like period unless written objection is theretofore declared and filed by the Association or by the Developer with Recorder of Stark County, Ohio.

Section 7.4 – Constructive Notice and Acceptance.

Every person who now or hereafter owns or acquires any rights, title or estate in any portion of the Development is and shall be conclusively deemed to have consented and agreed to every covenant, condition and restriction contained herein whether or not a reference to these Restrictions is contained in the instrument by which such person acquired an interest in said Development.

Section 7.5 – Rights of Mortgagee.

All provisions of these Restrictions, including the provisions hereof respecting liens and charges against the Development, shall be deemed subject and subordinate to the lien of all recorded first mortgages and mortgage deeds on or for the Development securing a debt, now or hereafter executed, and none of these Restrictions shall supersede or in any way reduce the security or affect the validity of such lien or mortgage or deed to secure such debt; provided, however, that if any portion of said Development is sold or conveyed under a foreclosure or other enforcement of any mortgage or under the provisions of any deed to secure debt, any grantee or purchaser at such sale, and his heirs, personal representatives, successors and assigns, shall hold any and all property so conveyed or purchased, subject to all the covenants, conditions, restrictions and liens, and other provisions of these Restrictions.

Section 7.6 – Mutuality/Enforcement.

All restrictions, conditions and covenants contained herein are made for the direct mutual and reciprocal benefit of the Developer, the Association, the lot owners and their successors and assigns; these Restrictions shall create mutual equitable servitude's upon the Development in favor of other real property in the Development; these Restrictions shall create reciprocal rights and obligations between the respective owners of all such property and privity of contract and estate between all Grantees thereof; and these Restrictions shall operate as covenants running with the land for the benefit of all such property and the owners thereof.

In the event the Developer and/or the Association takes any action, legally or otherwise, to enforce any provision of these Restrictions, the lot owner(s) against whom the action is taken shall be assessed for and be responsible to pay to the Developer and/or the Association any and all costs and expenses (including, but not limited to, discovery, court costs and/or reasonable attorney fees) incurred by the Developer and/or the Association related to the action.

Section 7.7 – Developer acting as Association or Board.

Until such time as all the lots in the Development have been sold to individuals or entities other than the Developer, or an entity controlled by the Developer, or at such earlier time as the Developer may elect, the Developer may, in its discretion, exercise all rights granted herein to the Association or the Architectural Review Board. The Developer, however, shall have no obligation to exercise such rights.

Section 7.8 – Applicability of Declaration.

The Declaration, as amended herein, shall be applied to all lot owners in the Development, regardless of whether such owners took title to their respective lot(s) prior to the date of this Amendment.

IN WITNESS WHEREOF, the Developer and owner of more than two-thirds of the lots in the Development has caused this Amendment to be executed as of the date first mentioned above.

McKINLEY-APPLEGROVE, LTD., an
Ohio limited liability company

By: McKinley Development Company, Ltd.,
an Ohio limited liability company
("Member")

By: 
Robert J. DeHoff, Member

By: 
William J. Lemmon, Member

STATE OF OHIO, STARK COUNTY, SS:

BEFORE ME, a Notary Public in and for said County and State, personally appeared the above-named, McKINLEY-APPLEGROVE, LTD., an Ohio limited liability company, by McKinley Development Company, Ltd., an Ohio limited liability company, its Member, by Robert J. DeHoff and William J. Lemmon, all of its members, who acknowledged that they did sign the foregoing instrument and that the same is their free act and deed, both individually and as said members and that that they are duly authorized to sign herein.

IN WITNESS WHEREOF, I have set my name and official seal at North Canton, Ohio, as of the 19th day of October, 2008.



Notary Public

This instrument prepared by:
Thomas W. Winkhart, Esq.
Winkhart & Rambacher, Attorneys at Law
825 South Main Street
North Canton, OH 44720
Telephone: 330-433-6700
Facsimile: 330-433-6701

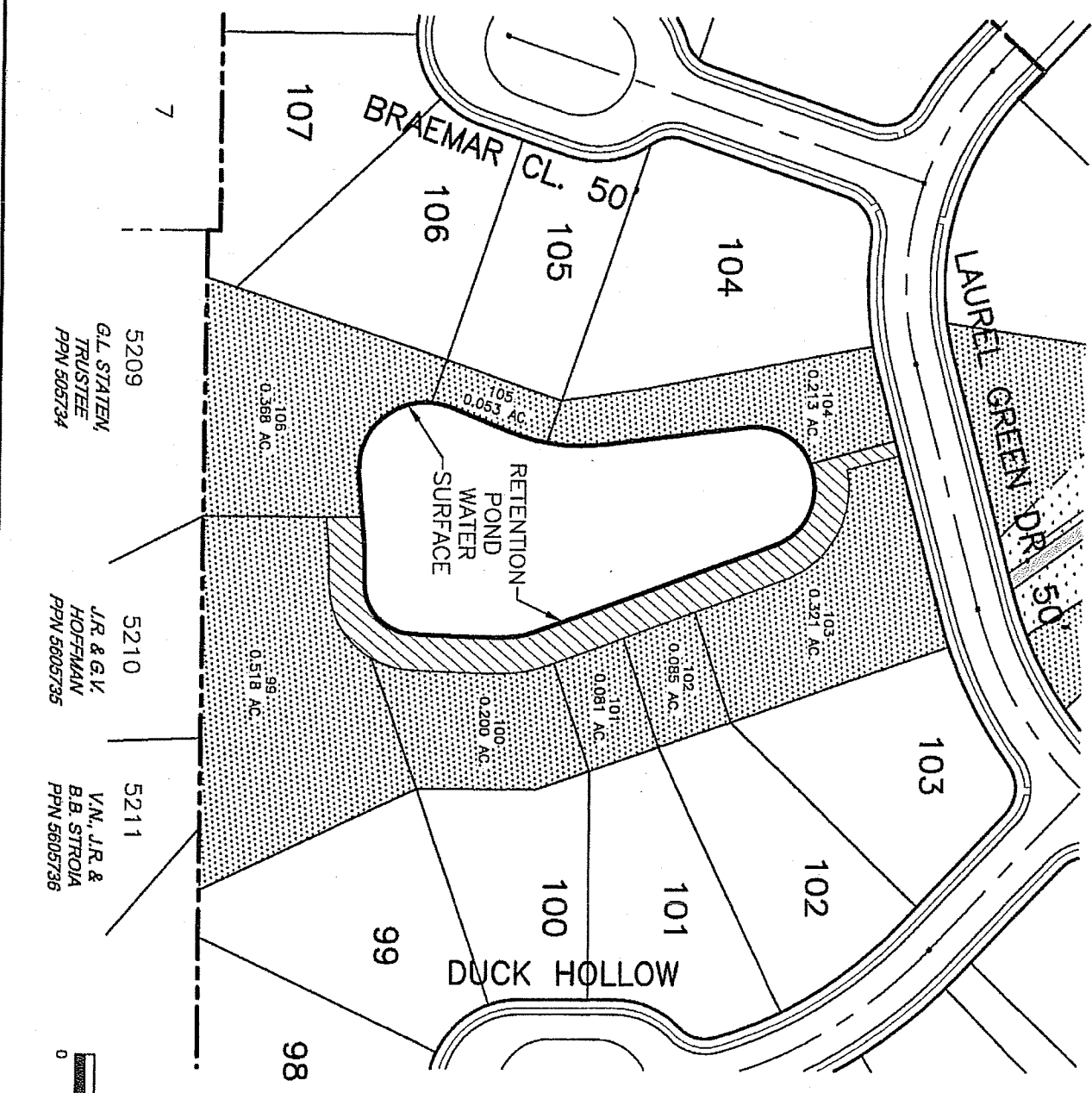

LINDA S. MILLER
NOTARY PUBLIC
IN AND FOR THE STATE OF OHIO
MY COMMISSION EXPIRES
10-25-2011

FOR CONTINUATION
SEE EXHIBIT "B" DRAWING 2



LEGEND

- = EXCLUSIVE EASEMENT
- = LIMITED COMMON AREA/ LOTS 99-103

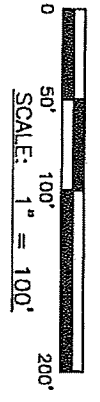
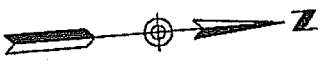

5209 G.L. STAIVEN, TRUSTEE PPN 5005734

5210 J.R. & G.V. HOFFMAN PPN 5005735

5211 V.N. J.R. & B.B. STROIA PPN 5005736



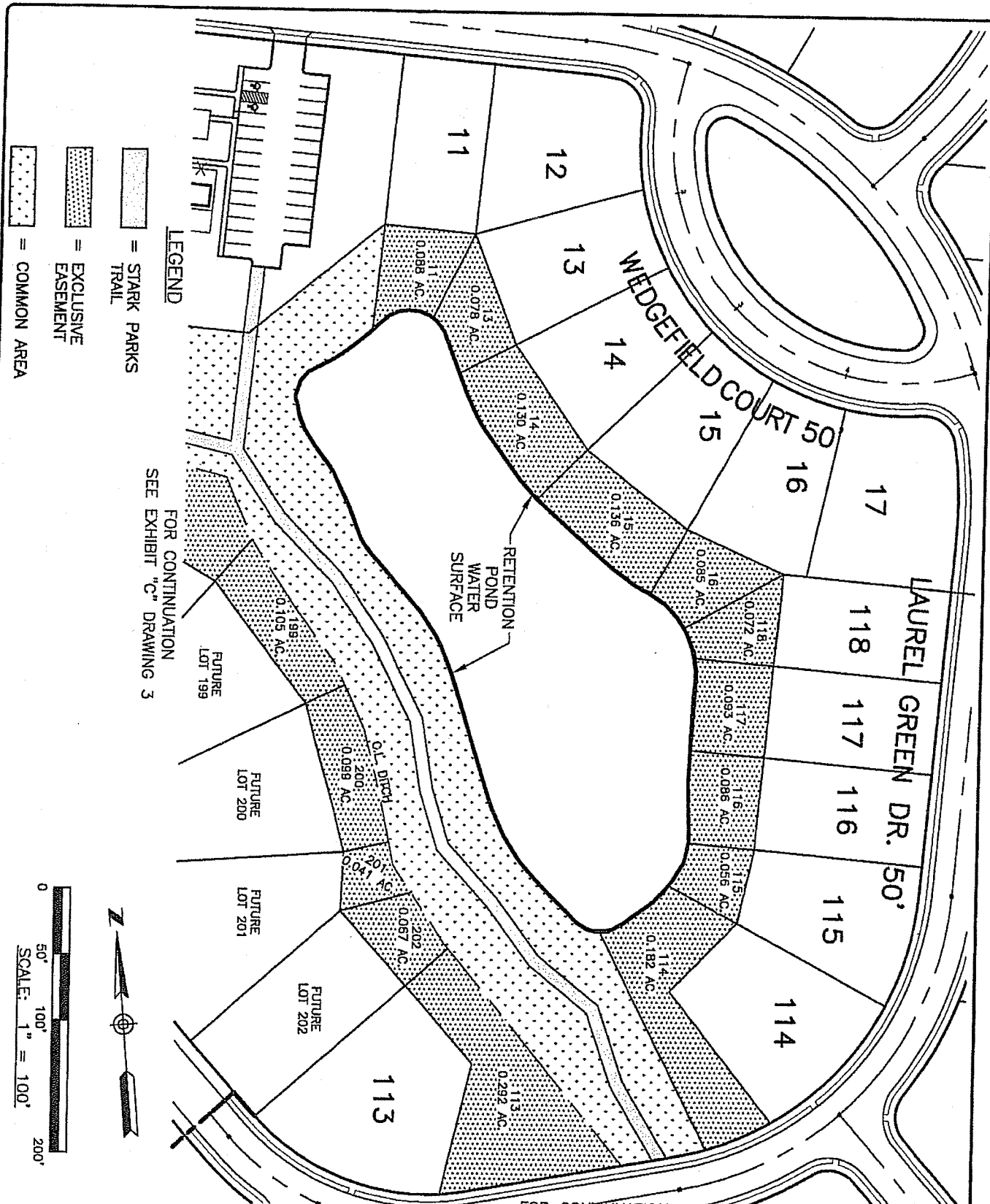

THE SANCTUARY NO. 1 & NO. 2 EXHIBIT "A"

GBC DESIGN, INC.
 8278 W. Market St. Akron, OH 44322-2265
 Phone 330-636-0223 Fax 330-636-0783

DATE	1/19/78
PROJECT NO.	311204
DRAWING NO.	1



LEGEND

-  = STARK PARKS
-  = TRAIL
-  = EXCLUSIVE EASEMENT
-  = COMMON AREA

FOR CONTINUATION
SEE EXHIBIT "C" DRAWING 3

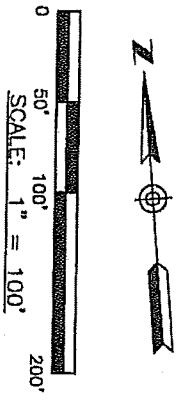

FOR CONTINUATION
SEE EXHIBIT "A" DRAWING 1

THE SANCTUARY NO. 1 & NO. 2 EXHIBIT "B"

GBC DESIGN, INC.
 8878 W. Market St.
 Parma, OH 44133-3826
 Phone 440-252-2225
 Fax 440-252-3783
 Akron, OH 44322-3826
 Fax 440-252-3783

DATE	1/18/08
PROJECT NO.	311354F
DRAWING NO.	2

FOR CONTINUATION
SEE EXHIBIT "D" DRAWING 4

FUTURE
LOT 184

1

2

3

4

5

6

7

8

9

10

LAUREL GREEN

DR. 50'

RETENTION-
POND
WATER
SURFACE

C.L. DITCH

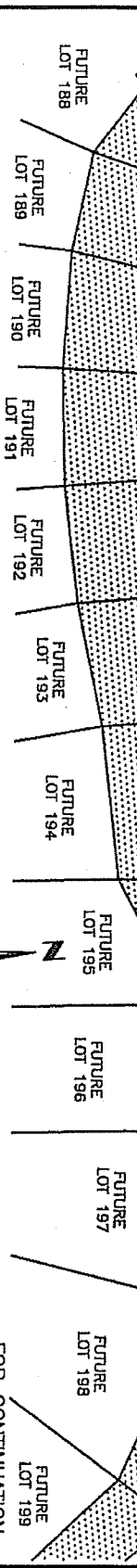

LOT	ACRES
E1	0.019
E2	0.020
E3	0.022
E4	0.022
E5	0.018
E6	0.021
E7	0.035
E8	0.032
E9	0.024
E10	0.105

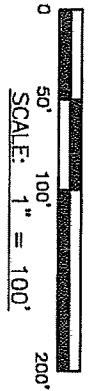

- LEGEND**
- [Stippled pattern] = STARK PARKS
 - [Dotted pattern] = EXCLUSIVE EASEMENT
 - [Cross-hatched pattern] = COMMON AREA

FOR CONTINUATION
SEE EXHIBIT "B"
DRAWING 2

THE SANCTUARY NO. 1 & NO. 2 EXHIBIT "C"

GBC DESIGN, INC.
 8378 W. Market St. Akron, OH 44333-8336
 Phone 330-846-0235 Fax 330-846-8733

DRAWING NO.	3
PROJECT NO.	317304F
DATE	1/1/98
DRAWN BY	BR

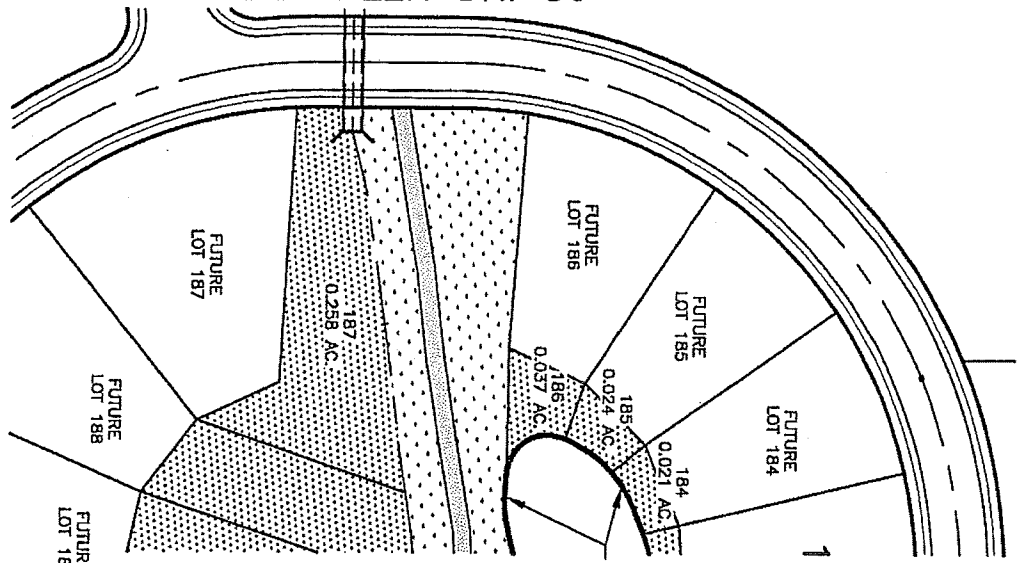

LAUREL GREEN DR. 50'

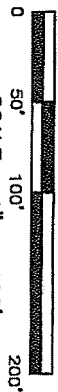

RETENTION POND WATER SURFACE

FOR CONTINUATION SEE EXHIBIT "C" DRAWING 3



- LEGEND**
-  = COMMON AREA
 -  = EXCLUSIVE EASEMENT
 -  = STARK PARKS TRAIL

THE SANCTUARY NO. 1 & NO. 2 EXHIBIT "D"

GBC DESIGN, INC.
 8376 W. Market St. Akron, OH 44333-5386
 Phone 330-290-0325 Fax 330-335-0723

DATE: 1/1/08
 PROJECT NO.: 3115XAF
 DRAWING NO.: 4

EXHIBIT "E"

LOT NUMBER	PHASE	EXCLUSIVE EASEMENT AREA ACREAGE
1	I	0.019 acres
2	I	0.020 acres
3	I	0.022 acres
4	I	0.022 acres
5	I	0.018 acres
6	I	0.021 acres
7	I	0.035 acres
8	I	0.032 acres
9	I	0.024 acres
10	I	0.106 acres
11	I	0.088 acres
13	I	0.078 acres
14	I	0.130 acres
15	I	0.136 acres
16	I	0.085 acres
99	II	0.518 acres
100	II	0.200 acres
101	II	0.081 acres
102	II	0.085 acres
103	II	0.321 acres
104	II	0.213 acres
105	II	0.053 acres
106	II	0.368 acres
113	II	0.292 acres
114	II	0.182 acres
115	II	0.056 acres
116	II	0.086 acres
117	II	0.093 acres
118	II	0.072 acres